

Varenummer: 201220441A
Beskrivelse: E+G Magnet m/gevindbøsning GN 50.2-HF-32-M4
Hård ferrit - 200° C, 80N

Mål

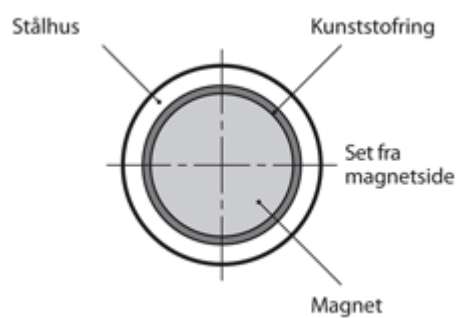
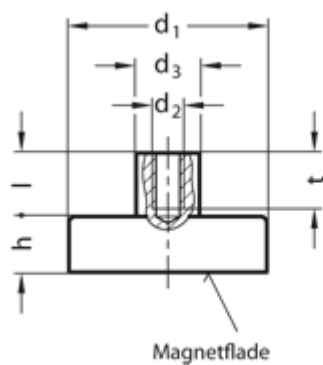

d1 = 32 ±0,1

d2 = M4x8

d3 = 8 ±0,1

h = 7 +0,3/-0,1

Holdekraft N = 80

Materiale = HF Hård ferrit - 200° C

t = 7